



20 Litre silver digital microwave with grill



User's manual

Model number: RHM2013

Please read these instructions carefully and keep
for future reference.

Contents

	Page
About this microwave oven	1
Safety instructions	2
Microwave oven Installation	4
Feature diagram	5
Control panel	6
Knowing your microwave oven	7
Using your microwave oven	7
Setting the clock.....	7
Express cooking.....	7
Cooking with different power levels.....	8
Using the grill.....	8
Defrosting foods.....	9
Weight defrost.....	9
Jet defrost.....	9
Preset function.....	9
Combination cooking.....	10
Multi-stage cooking.....	10
Using the auto menus.....	11
Child proof lock.....	11
Useful tips	11
Standing time.....	11
Stirring.....	11
Turning and rotating.....	11
Arranging food.....	11
Auto menu chart.....	12
Cooking utensils	13
Trouble shooting	13
Cleaning and care	13
Use this page for your recipes	14
Connection to the mains supply	15
Specifications	15

About this microwave oven

Microwaves are high-frequency electromagnetic waves similar to radio waves. While radio waves may vary in length from one metre to many kilometres, microwaves are very short (less than 12.5 centimetres). Microwaves do not make any heat themselves but only cause water molecules in food to vibrate. This vibration produces heat that cooks the food. This is why your food will come out of the microwave piping hot, when your utensils inside the oven stay much cooler. The microwaves do not stay in the air or in the food when you open the microwave oven door.

The microwave oven will work using an ordinary household electrical socket. Inside the microwave oven is the magnetron, which turns the electrical energy into microwaves. Microwaves cannot go through metal, so the inside of the oven is lined with metal. The door is lined with a fine metal mesh which stops microwaves getting through. This means that when the microwave oven door is shut, there is no possibility that microwaves can be released.

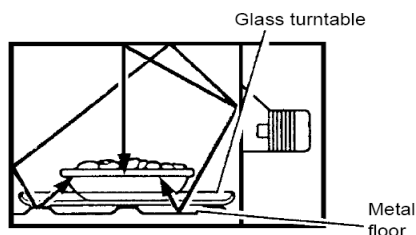
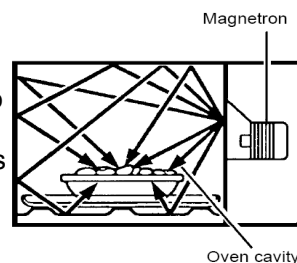

Microwaves pass through the glass turntable and then bounce off the metal floor, back through the turntable, and are absorbed by the food.

Microwaves may not reach the center of a roast. The heat spreads to the center from the outer cooked areas just like regular cooking. For this reason food should stand for a while after cooking.

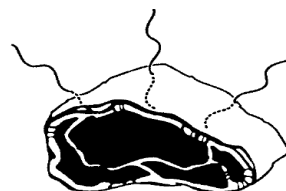

Before you use your microwave oven

- 1 Remove all the packaging. Do not remove the small piece of card from the right hand side of the cavity wall. This is called a wave-guide cover and allows the microwaves to pass through to cook the food.
- 2 Check the oven after unpacking for any visual damage such as:
 - a misaligned door
 - damage to the door
 - dents or holes in the door window and screen
 - dents in the inside
 - If you can see any damage **do not** use the oven

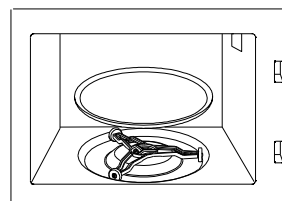

This microwave oven weighs approximately 12.5kg so you must put it on a horizontal surface that is strong enough to support this weight.

The oven must be placed away from high temperatures and steam.

Do not put anything on the top of the microwave oven.





Only use the accessories supplied by the manufacturer.

Safety instructions

Warning: to reduce the risk of burns, electric shock, fire, injury or exposure to excessive microwave energy:

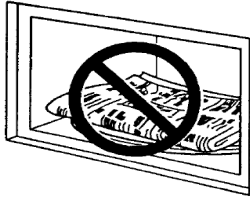
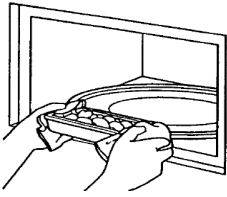
- Use this microwave oven for only its intended use as described in this instruction manual.
- Do not operate the microwave oven if it has a damaged power cord or plug, if it is not working properly, or if it has been damaged or dropped.
- Do not block the air vents, this can damage the microwave oven and cause poor cooking results.
- Never put any objects into the openings on the outer case.
- Never remove parts from the oven such as the feet, screws and so on.
- Do not try to deep-fry foods in this oven.
- None-microwavable cookware is not suitable and can be hazardous.
- When heating or cooking food or liquid, remember that there are certain foods (such as Christmas puddings, jam and mincemeat) which heat up very quickly.
- When heating or cooking foods that contain a lot of fat or sugar, do not use plastic containers.
- Do not cook food directly on the turntable. Put food on a suitable plate or in a bowl before putting it in the oven.
- Do not store the microwave oven outdoors.
- Do not use the microwave oven near water- for example, near a sink and the like.
- Do not immerse the power cord in water.
- Do not allow the power cord to hang over the table or surface.
- If the power cord needs replacing, it must be replaced with a cord of the same type by a qualified technician.
- Keep the power cord away from heated surfaces.
- Do not over cook food, this can result in fire.
- Some products such as whole eggs in their shell and sealed containers, for example, closed glass jars, may explode and should not be heated in the microwave oven.
- Do not place any objects or allow cleaning residue to come between the oven face and the door seals.
- This appliance is not intended for use by persons (including children) with reduced physical, sensory or mental capabilities, or lack of experience and knowledge, unless they have been given supervision or instruction concerning use of the appliance by a person responsible for their safety.
- Children should be supervised to make sure that they do not play with the appliance.
- Never leave the microwave oven unattended while in use.
- **Warning:** it is hazardous for anyone other than a competent person to carry out any service or repair operation which involves the removal of a cover which gives protection against exposure to microwave energy.
- **Warning:** if the door or door seals are damaged, the oven must not be operated until it has been repaired by a competent person. The door seals are located around the window on the inside of the door. These seals are not airtight, although no microwaves can be released, it is normal for small amounts of air or steam to escape when the oven is in use.
- **Warning:** liquids and other foods must not be heated in sealed containers as they are liable to explode.

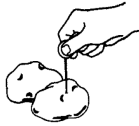
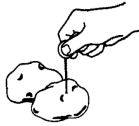
Safety instructions

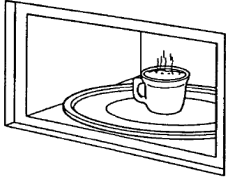
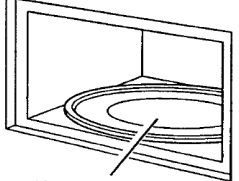
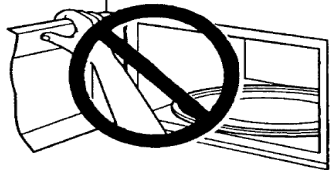
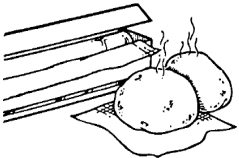
- Do not store anything in the oven, such as papers, cookbooks and so on. Do not use the oven for any reason other than preparing food, such as for drying clothes, paper or any other non-food items, or for sterilising purposes.
 
- Cooking utensils may become hot because of heat transferred from the heated food, so please be careful when removing it from the oven. Please remember that the food or liquid inside will be releasing some steam or will be spitting. Never cover any container fully, always leave a gap for steam to escape. This is especially true if plastic wrap has been covering the top and handles of the utensil. You may need oven gloves to handle the utensil. You should use microwave utensils only in line with these instructions.
 
- The contents of feeding bottles and baby food jars shall be stirred or shaken and the temperature checked before consumption, in order to avoid burns. Always remove the teat from feeding bottles if they need to be reheated.
 
- Always test the temperature of cooked food, never eat or drink food or liquid straight from the oven, allow it to stand for a few minutes and stir to distribute the heat evenly.
 
- Do not cook any food surrounded by a membrane, such as egg yolks, potatoes, chicken livers, ready meals and so on without piercing them several times with a fork.
 
- Food containing a mixture of fat and water (for example, stock) should stand for 30 to 60 seconds in the oven after it has been turned off. This is to allow the mixture to settle and to prevent it from bubbling when a spoon is placed in it, or a stock cube is added.
 
- Do not use the oven when it is empty. This could damage the oven. If you want to practice the programming of the oven, put a container of water in the oven.
 
- Always have the glass turntable and turntable support in place when using the oven.
 
- Never lean on the microwave oven door or allow a child to swing on it, this could result in injury.
 
- Do not over cook potatoes. This could result in fire. At the end of the cooking time potatoes should be slightly firm because they will continue to cook during the standing time. Remove from the microwave oven, wrap in tin foil and leave to stand for 5 minutes.
 

Microwave oven Installation

- 1 Select a level surface that provides enough space for the outlet vents.
- 2 A minimum clearance of 3 inches (7.5cm) is required between the oven and any adjacent walls. One side must be open. Leave a minimum clearance of 12 inches (30cm) above the oven.
- 3 Place the oven as far away from radios and TV's as possible. Using the oven may cause interference with the reception.
- 4 Open the oven door and take out the accessories, clean the inside with a soft, damp cloth. Place the turntable support and the turntable in the cavity.
- 5 Plug the oven into a suitable 13Amp mains socket, make sure the voltage the same as on the rating label (do not use extension cables or mains socket adaptors).

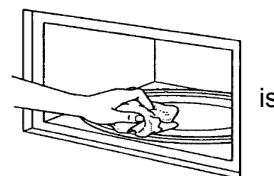

Warning: do not install the microwave oven over a cooker or other heat producing appliance, this will damage the oven. Do not install over a sink.

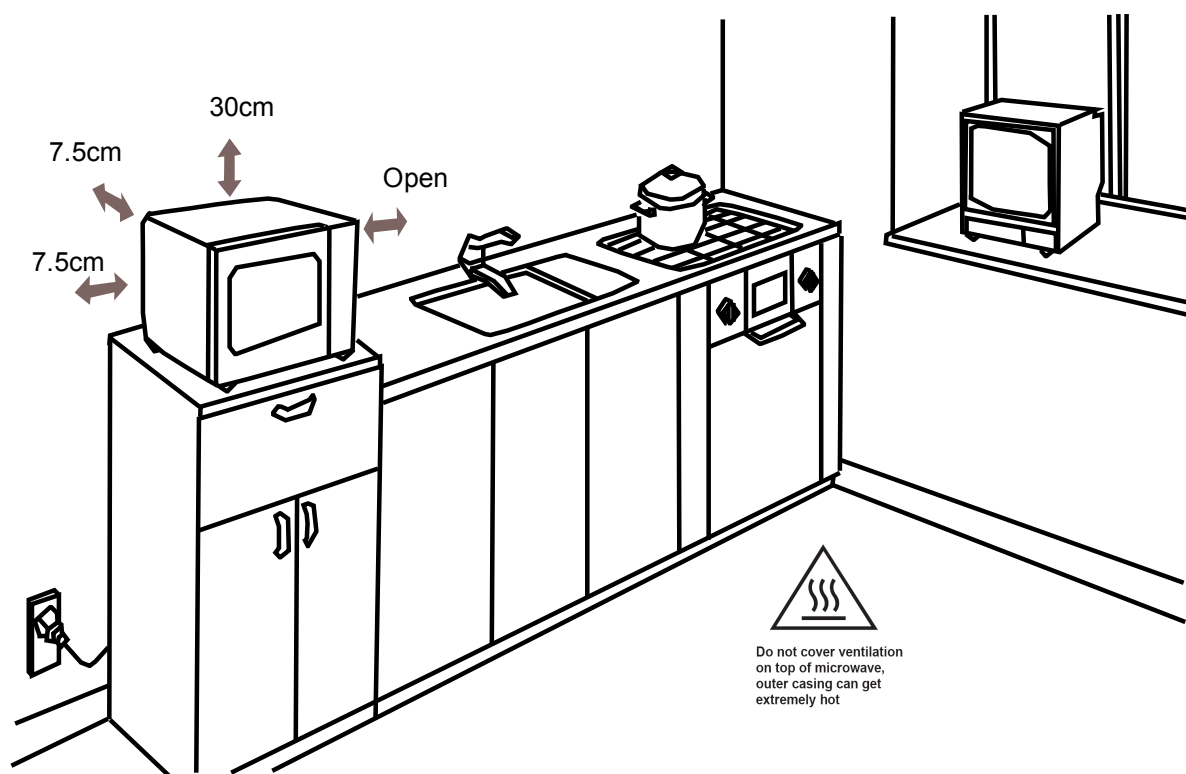

Do not operate the microwave oven unless the turntable is securely in place and can rotate freely. It is normal for the turntable to rotate in either direction.

Make sure the turntable is the correct side up. Carefully place cookware onto the turntable to avoid possible breakage.

When removing the turntable from the microwave oven, handle with care.

Feature diagram

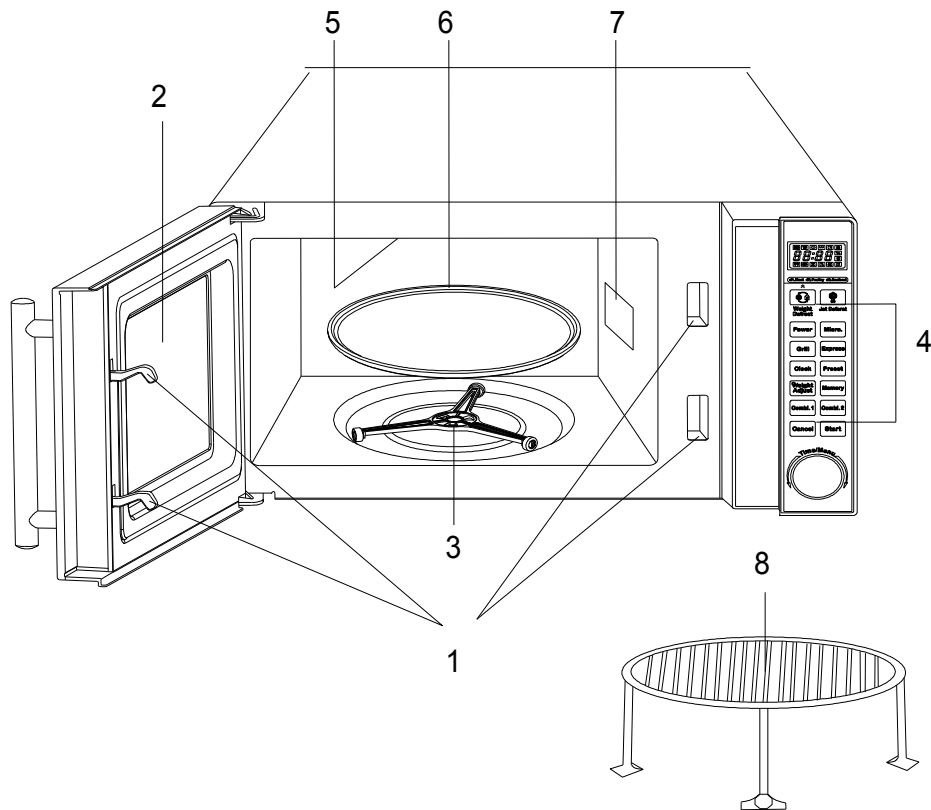

Your microwave oven is designed to make cooking an enjoyable and productive experience. To get you up and running, the following is a list of the oven's basic features:

- | | | |
|---|----------------------------------|--|
| 1 | Door safety lock system | The oven will not operate unless the door is securely closed |
| 2 | Oven window | Shield prevents microwaves from escaping |
| 3 | Turntable support | Under the turntable |
| 4 | Control panel | Touch pads on the panel to perform all functions |
| 5 | Grill | Grills food with or without microwave assistance. |
| 6 | Turntable | The turntable turns food as it cooks. It must be used during operation |
| 7 | Wave guide cover (Do not remove) | This allows the microwaves through to cook the food |
| 8 | Grill rack | Use when grilling foods |

Control panel

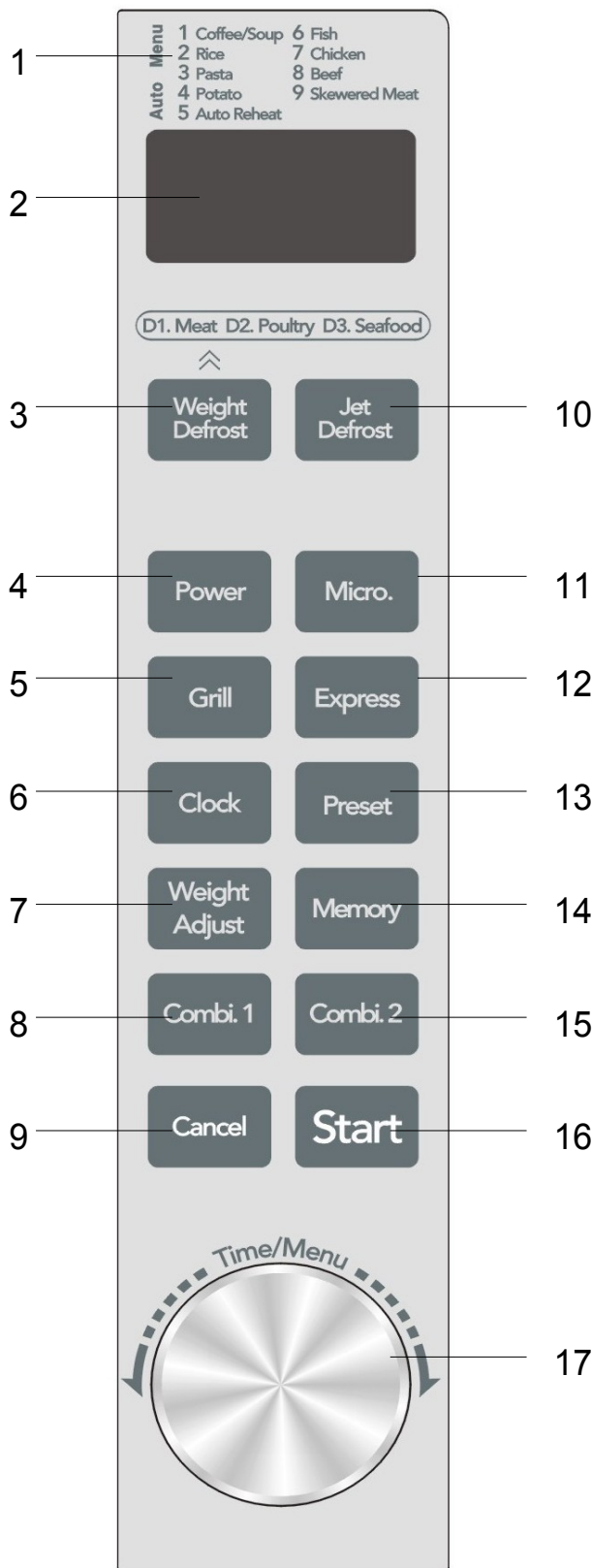

- 1 **Auto menu**
Shows the auto menus that are available by turning the 'Time/Menu' control clockwise or anti-clockwise. See page 12.
- 2 **Display**
The display shows the time of day, cooking settings and functions.
- 3 **Weight Defrost**
Touch to defrost food by weight. See page 9.
- 4 **Power**
Touch this button a number of times to set a cooking power level. See page 8.
- 5 **Grill**
Press to select the grill function. See page 8.
- 6 **Clock**
Touch this pad followed by the 'Time/Menu' knob to set the time of day. See page 7.
- 7 **Weight adjust**
Touch this pad to adjust the weights of an Auto menu selected. See page 11.
- 8 **Combi 1**
Cooks using 30% microwave and 70%grill. See page 10.
- 9 **Cancel**
Touch this pad to erase an incorrect command or to cancel a program during cooking. See page 7.
- 10 **Jet defrost**
Touch this pad followed by the 'Time/Menu' control to set a defrost time. See page 9.
- 11 **Micro**
Touch this pad to choose the micro setting. See page 8.
- 12 **Express**
Touch this pad to program the oven to automatically start at 100% microwave power. See page 7.
- 13 **Preset**
This function allows you to set the microwave oven to start at a later time. See page 9.
- 14 **Memory**
Used when setting a multi-stage cooking program. See page 10.
- 15 **Combi 2**
Cooks using 55% microwave and 45%grill. See page 10.
- 16 **Start**
Touch to start a cooking program.
- 17 **Time/Menu**
To set a cooking time. To choose an auto menu.

Knowing your microwave oven

Notes

If you choose a program but do not press another command within one minute, the display will return to the time of day and a tone will sound.

Symbols will appear on the display to guide you when setting and using your oven.

When cooking has finished, four tones will sound and the display will show 'End'. Two tones will sound every two minutes until the door is opened or the 'Cancel' pad is touched.

You can stop the cooking process at any time by two methods:

- Opening the oven door, the light will remain on but the microwave oven stops the heating process and the fan will stop. To resume cooking close the door and touch the 'Start' pad.
- Or, touching the 'Cancel' pad. To cancel the cooking program completely, touch the 'Cancel' pad again.

Always cook food for the shortest cooking time recommended. During cooking check occasionally to see if the cooking time you set is sufficient.

If you do not have a cover for the dish you are cooking food in, use microwaveable cling film. Remember to leave a gap for steam to escape during cooking.

Using your microwave oven

Setting the clock

When your microwave oven is plugged in for the first time, or if there has been a power failure, the display will show '1 :01' and the clock symbol will be displayed. These will stay on the display until the clock or another function is set.

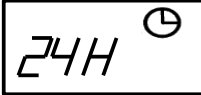
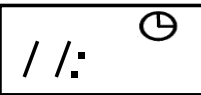
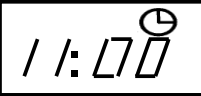
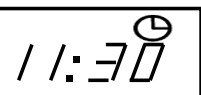

The clock can only be set if the oven is not cooking food.

To set the time, for example 11:30am

- 1 Touch the 'Clock' pad, the display will show. 
- 2 Turn the 'Time/Menu' control to set the hour. The clock symbol will flash. 
- 3 Touch the 'Clock' pad. The display will show. 
- 4 Turn the 'Time/Menu' knob to set the minutes. The clock symbol will continue to flash. 
- 5 To confirm the time, touch the 'Clock' pad. The clock display will stay lit, and the ':' symbols will flash.

Express microwave cooking

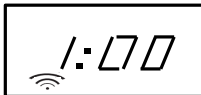
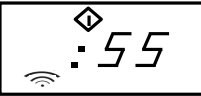

The express function allows you to cook food using 100% power from 30 seconds and up to 10 minutes. With each press of the 'Express' touch pad the time is extended by 30 seconds up to 2 minutes, and 60 seconds after 2 minutes. Once you have set a time the microwave oven will automatically operate and start to cook the food. For example, to set the express function to cook for 1 min:

- 1 Touch the 'Express' pad twice, the oven will begin to cook and start to count down. The display will show. 
- 2 If cooking is interrupted by touching the cancel pad, cooking will be paused and the following display will show and the 'Start' indicator will flash. To resume cooking touch the 'Start' pad. 
- 3 When cooking has finished, four tones will sound and 'END' will be displayed. Two tones will sound every two minutes until the door is opened or the 'Cancel' pad is touched. 

Cooking with different power levels

You can cook with different power levels and cooking times by touching the 'Power', 'Micro.' pads and turning the 'Time/Menu' control. The lower the power level, the slower the cooking. There are 5 power levels to choose from, 100%, 80%, 60%, 40% and 20%. (00% is for a kitchen timer only, see below chart).

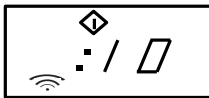
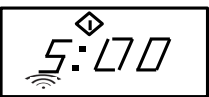
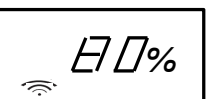
The following example shows you how to cook food on power level 80% for 5 minutes:

- 1 Touch the 'Micro' pad. The display will show the following. 
- 2 To choose the length of time you want to cook the food for, turn the 'Time/Menu' knob. 
- 3 Touch the 'Power' pad and select a power level to suit the food that you are cooking. 
- 4 Touch the 'Start' pad.
- 5 When cooking has finished, four tones will sound and 'END' will be displayed. Two tones will sound every two minutes until the door is opened or the 'Cancel' pad is touched. 

Note: during cooking you can check the current power level by pressing the 'Power' button.



The Power level chart below gives the percentages of each power level. It also tells you when to use each power level. Please follow the instructions on the

packaging of foods if available. Refer to a reliable cookbook for cooking times.

Using the grill

Cooking using the grill is particularly useful for thin slices of meat, such as steaks, chops, kebabs, sausages and pieces of chicken. When using the grill function it is advisable to use the grill rack to place the food on, please make sure you put a suitable plate or dish under the grill rack to catch any fluids they may drip from the food. The maximum grilling time is 60 minutes.

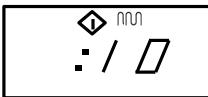
The following example shows you how to grill food for 10 minutes:

- 1 Touch the 'Grill' pad. The display will show. 
- 2 Turn the 'Time/Menu' control to set the time. 
- 3 Touch the 'Start' pad.
- Note:** half way through the cooking time the oven will stop and two tones will sound. This is to allow you to turn the food over for even cooking. To resume cooking, touch the 'Start' pad.
- 4 When cooking has finished, four tones will sound and 'END' will be displayed. Two tones will sound every two minutes until the door is opened or the 'Cancel' pad is touched. 

Power level chart

Power level	Setting	When to use it
100%	High	Quick heating of many convenience foods, and foods with a high water content such as, soups and beverages. Cooking smaller tender pieces of meat, minced meat, poultry pieces, fish fillets and vegetables.
80%	Medium high	Cooking and heating foods that need to cook on a lower power than 100% such as, whole fish and meat loaf. Reheating casseroles. Reheating a single serving of food.
60%	Medium	Cooking food that requires special care, such as cheese and egg dishes, puddings and custards.
40%	Medium low	Cooking pot roasts, simmering stews and heating pastries.
20%	Low	Softening butter, cheese and ice cream.
00%	Kitchen timer	Your microwave oven can be used as a kitchen timer. This is useful if you want to set a reminder. When 00% is chosen no microwaves are present but the fan will still be heard. You can set a reminder between 10 seconds and 60 minutes. Once the timer has been set the display will count down.

Defrosting foods

- Before defrosting, make sure you have removed any metal twist-ties which often come with frozen food bags.
- Open containers before they are placed in the microwave oven.
- Always pierce plastic pouches or packages. Always shake gently to ensure even defrosting.
- If food is wrapped in foil, remove it and place the food in a suitable container.
- Pierce the skins of frozen foods such as sausages.
- The length of defrosting time depends on how solid the food is, if the food is still icy in the center, return it to the microwave oven for more defrosting.
- As food starts to defrost, separate or remove the pieces, it will defrost more easily.
- Turn food over for even defrosting.
- For best results, let the food stand after defrosting.

Weight defrost

This microwave oven allows you to defrost meat, poultry and seafood by weight. The range of weights varies between 100g and 1800g.

The defrost display will show:

- d1 – Meat
- d2 – Poultry
- d3 - Seafood

For example, if you want to defrost 600g of poultry:

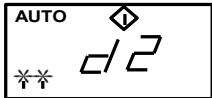
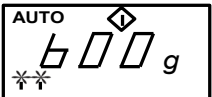
- 1 Touch the 'Weight Defrost' pad until the display shows 'd2' 
- 2 Turn the 'Time/Menu' control to set the weight. The display will show. 
- 3 Touch the 'Start' pad. The microwave oven will automatically decide how long it will take to defrost the poultry and the time will start to count down.



Note: two thirds through the defrosting time the oven will stop and two tones will sound. This is to allow you to turn the food over for even cooking. To resume cooking, touch the 'Start' pad.

- 4 When cooking has finished, four tones will sound and 'END' will be displayed. Two tones will sound every two minutes until the door is opened or the 'Cancel' pad is touched. 

Jet defrost

The microwave oven can quickly defrost food to the set time entered. The maximum defrost time is 60 minutes.

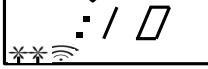

For example, if you want to defrost food for 10 minutes:

- 1 Touch the 'Jet defrost' pad. The display will show. 
 - 2 Turn the 'Time/Menu' control to set the time. 
 - 3 Touch the 'Start' pad to start defrosting.
- Note:** two thirds through the defrosting time the oven will stop and two tones will sound. This is to allow you to turn the food over for even cooking. To resume cooking, touch the 'Start' pad.
- 4 When cooking has finished, four tones will sound and 'END' will be displayed. Two tones will sound every two minutes until the door is opened or the 'Cancel' pad is touched. 

Preset function

The preset function allows you to preset the microwave oven to start at a later time. The correct time of day must be set when using this function.

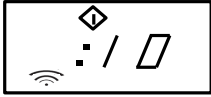
The following example shows you how to preset the microwave oven to cook food on power level 80% and for 5 minutes. If your clock is set for 10:20 and you want the microwave oven to start at 11:30:

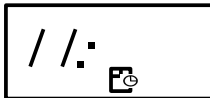
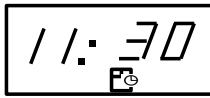
- 1 Touch the 'Micro' pad. The display will show the following. 
- 2 To choose the length of time you want to cook the food for, turn the 'Time/Menu' control.. 
- 3 Touch the 'Power' pad and select a power level. 
- 4 Touch the 'Preset' pad. The hour digits will flash. Turn the 'Time/Menu' control to set the hour. 
- 5 Touch the 'Preset' pad. The Minute digits will flash. Turn the 'Time/Menu' control to set the minutes. 
- 6 Touch the 'Start' pad. The microwave oven has now been preset, the preset symbol will flash until the time set is reached and the microwave oven will start.

- 7 When cooking has finished, four tones will sound and 'END' will be displayed. Two tones will sound every two minutes until the door is opened or the 'Cancel' pad is touched.



Combination cooking

The combination setting allows you to combine the grill function and the microwave function. There are 2 combinations you can use, combination 1 and combination 2.

Combination 1 – the microwave oven works with 30% microwave power and 70% grill power. This is ideal for foods such as fish, chops and so on.

For example, if you want to cook food on combination 1 for 15 minutes:

- 1 Place the food on the rack, making sure there is a suitable container is under it to collect any drips.
- 2 Touch the 'Combi 1' pad. The display will show the following.
- 3 Turn the 'Time/Menu' control to set the time. The display will show.
- 4 Touch the 'Start' pad to start combination cooking.

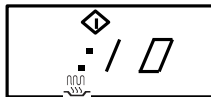

Note: two thirds through the cooking time the oven will stop and two tones will sound. This is to allow you to turn the food over for even cooking. To resume cooking, touch the 'Start' pad.

- 5 When cooking has finished, four tones will sound and 'END' will be displayed. Two tones will sound every two minutes until the door is opened or the 'Cancel' pad is touched.



Combination 2 – the microwave oven works with 55% microwave power and 45% grill power. This is ideal for foods such as puddings, omelet, baked potatoes and poultry.

For example, if you want to cook food on combination 2 for 15 minutes:

- 1 Place the food on the rack, making sure there is a suitable container is under it to collect any drips.
- 2 Touch the 'Combi 2' pad. The display will show the following.
- 3 Turn the 'Time/Menu' control to set the time. The display will show.



- 4 Touch the 'Start' pad to start combination cooking.

Note: two thirds through the cooking time the oven will stop and two tones will sound. This is to allow you to turn the food over for even cooking. To resume cooking, touch the 'Start' pad.

- 5 When cooking has finished, four tones will sound and 'END' will be displayed. Two tones will sound every two minutes until the door is opened or the 'Cancel' pad is touched.



Multi-stage cooking

Your microwave oven can be programmed for up to 3 automatic sequences.

For example, if you want to defrost food for 10 minutes, microwave food for 5 minutes and then grill food for 10 minutes:

- 1 Touch the 'Jet defrost' pad. The display will show.
- 2 Turn the 'Time/Menu' control to set the time.
- 3 Touch the 'Memory' pad. The display will show.
- 4 Touch the 'Micro' pad. The display will show the following.
- 5 To choose the length of time you want to cook the food for, turn the 'Time/Menu' control.
- 6 Touch the 'Memory' pad. The display will show.
- 7 Touch the 'Grill' pad. The display will show the following.
- 8 Turn the 'Time/Menu' control to set the time.

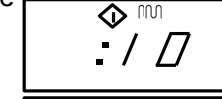
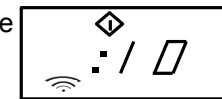
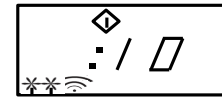

- 9 Touch the 'Start' pad.

Note: two thirds through the defrosting time the oven will stop and two tones will sound. This is to allow you to turn the food over for even cooking. To resume cooking, touch the 'Start' pad.

- 10 When cooking has finished, four tones will sound and 'END' will be displayed. Two tones will sound every two minutes until the door is opened or the 'Cancel' pad is touched.

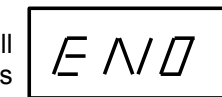

Using the auto menus

When using the auto menu it is important that you set a weight or amount to determine how long the food needs to be cooked for, without this food may be under or over cooked. Please look at the weights on packaging, if the food is between weights, please make sure the food is cooked thoroughly before eating. Never over cook food, this can result in fire. The result of auto cooking depends on food factors such as shape and size, and your personal preference as to how you like your food cooked. How you place the food on the plate can also effect the end result. If you find the result not quite satisfactory, please adjust the cooking time accordingly.

Note: When you are using auto menus '7 Chicken', '8 Beef' and '9 Skewered meat', two thirds through the cooking cycle 4 tones will sound. This is to remind you to turn the food over for even cooking. Once the food has been turned over, close the door and touch the 'Start' pad.

The auto menus are featured at the top of the control panel, there are nine auto menus available. The 'Time/Menu' control lets you choose an auto menu quickly and easily. Once you have chosen an auto menu, you will need to set a weight or amount.

For example, if you want to cook 1000g of chicken using the auto setting:

- 1 Turn the 'Time/Menu' control clockwise or anti-clock until the display shows 'AUTO 7'.

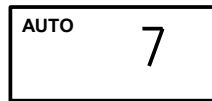

- 2 To set the weight, touch the 'Weight Adjust' pad twice.

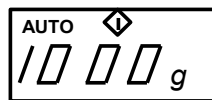

- 3 Touch the 'Start' pad. The microwave oven will automatically decide how long it will take to cook the chicken and the time will start to count down.

- 4 When cooking has finished, four tones will sound and 'END' will be displayed. Two tones will sound every two minutes until the door is opened or the 'Cancel' pad is touched.

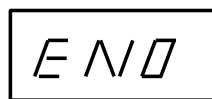

For further information on the Auto menus, please see the Auto menu chart on page 12.

Child proof lock

The child proof lock prevents unsupervised operation by children.

To set the child proof lock: Touch the 'Cancel' pad for approximately 3 seconds, a single tone will sound and the lock indicator will be displayed.

To cancel the child proof lock: Touch the 'Cancel' pad for approximately 3 seconds, a single tone will sound and the lock indicator will disappear.

Useful tips

Standing time

Food still continues to cook by conductive heat towards the center of the food after it has been removed from the microwave oven, or after the microwave oven has been turned off. This is called standing time. The standing time varies according to the volume and density of the food.

To retain the heat, large items of foods such as poultry or meats should be wrapped in tin foil during the standing time for 10-20 minutes.

Stirring

Stirring is useful because the food cooks from the outer edges inward. Therefore stirring from the outer edges to the center during cooking encourages even cooking.



Turning and rotating

It is possible that sometimes microwave energy is not distributed evenly in the cavity of the microwave oven. Foods such as joints of meat poultry should be turned over at least once during cooking.



Arranging food

For best results, arrange food evenly on the plate. You can do this in several ways:

- If you are cooking more than 1 item, arrange the food in a ring for even cooking.
- If you are cooking foods that are uneven shapes and thicknesses, put the smaller or thinner foods towards the center of the plate where they will be heated last.
- If you are saving a meal in the refrigerator or plating a meal for reheating, arrange the thicker, denser foods to the outside of the plate and the thinner or less dense foods on the inside.
- Gravy and sauces should be reheated in a separate container. Choose a tall, narrow container rather than a low wide container, do not fill more than two thirds.

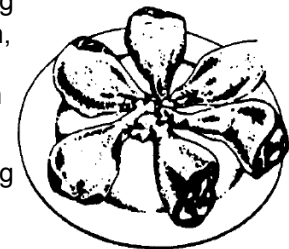

Auto menu chart

Auto menu	Food	Weights	Recommendations
1	Coffee/Soup	200g 300g 400g	Put in a suitable container and place on the center of the turntable. After removing from the microwave oven, leave to stand before adding anything.
2	Rice	150g, 300g 450g, 600g	Put in a suitable container and place on the center of the turntable. Refer to the manufacturers instructions on the packet.
3	Pasta	100g 200g 300g	Put in a suitable container and place on the center of the turntable. Refer to the manufacturers instructions on the packet.
4	Potato	150g 300g 450g	Prick the skin, put on a suitable plate and place on the center of the turntable. Turn the potato over for even cooking.
5	Auto reheat	200g, 300g, 400g, 500g, 600g, 700g 800g	Straight from the refrigerator.
6	Fish	200g, 300g 400g, 500g 600g	Put in a suitable container, cover with microwave safe cling film and place on the center of the turntable.
7	Chicken	800g, 1000g 1200g, 1400g	A combination of microwave and grill. Put in a suitable container and place on the center of the turntable. The rack can also be used.
8	Beef	200g, 300g 400g, 500g 600g,	A combination of microwave and grill. Put in a suitable container and place on the center of the turntable. The rack can also be used.
9	Skewered meat	100g, 200g, 300g, 400g, 500g	A combination of microwave and grill. Put in a suitable container and place on the center of the turntable. The rack can also be used. Note: if you are using metal skewers, please make sure they do not touch the cavity walls.

Cooking utensils

Utensils and cooking containers used in a microwave oven should be of a material that allows microwaves to pass freely through them. Generally this means you should use either plastic, glass or ceramic.

Ceramic is an excellent choice, most types of glass is also very good. Lead crystal can crack, therefore it should not be used. Coloured glass or decorative glass should not be used since metal, for example; gold, might be a part of the decoration and may cause arching.

Round or oval shaped containers give the most even cooking. Square containers may over cook food in the corners due to more energy being absorbed there.

Metal containers should not be used. Microwaves cannot penetrate metal, they bounce off any metal object and cause arching which resembles lightning.

Note: there are a number of microwave oven accessories available on the market, before you buy, please make sure they are suitable for microwave use.

Note: when putting food into the microwave oven, make sure that the food, food containers or covering do not come in contact with any of the cavity walls or ceiling.

Trouble shooting

The turntable will not turn

- The turntable is not correctly in place. Make sure the turntable is the correct side up and sitting on the turntable support.
- Check the turntable support is correctly placed.

The display shows the time counting down but the microwave oven is not cooking

- Check you have selected a power level between 20% - 100%, and not the kitchen timer.

The microwave oven does not work

- Check the plug is properly inserted into the mains socket.
- Is the door closed properly?
- Check the plug fuse and make sure there is power available.
- Unplug from the mains wait 10 minutes reconnect, and then try to operate the microwave oven again.
- The microwave oven may cause interference to your radio, TV or similar equipment. If it does, you can get rid of the interference by moving the radio, TV or equipment as far away from your microwave oven as possible.

Cleaning and care

To make sure your microwave oven looks good and works well for a long time, you should follow these instructions:

- Unplug from the mains supply before cleaning.
- Wipe the interior walls, floor and ceiling with a damp cloth using only a mild detergent.
- Be sure to keep the door and door frame clean at all times.
- Always clean under the turntable as any liquid that may have accumulated will damage the surface of the microwave oven.
- For stubborn marks, boil a cup of water in the microwave oven for 2 to 3 minutes, steam will often soften dried on food.
- Clean the turntable and turntable support regularly in warm soapy water.
- Clean the exterior with a soft damp cloth and wipe dry. Do not allow water to seep into the air vents.
- Do not allow the control panel to become wet, clean with a soft damp cloth and then dry.
- Do not use abrasives, these will damage the microwave oven.
- Remove odours from the microwave oven by combining a cup of water with the juice of 1 lemon in a deep bowl, microwave for 5 minutes. Wipe thoroughly with a soft dry cloth.
- The oven should be cleaned regularly and food deposits removed. Failure to maintain the microwave oven in a clean condition could lead to deterioration of the surface that could adversely affect the life of the appliance and possibly result in a hazardous.
- Should the bulb need replacing, please consult a qualified technician to have it replaced.

Warning: service should only be carried out by a service technician. It is dangerous for anyone other than a qualified technician to perform any repair.

Connection to the mains supply

WARNING- THIS APPLIANCE MUST BE EARTHED

This appliance is designed to operate from a mains supply of AC230V ~ 50HZ.
Check that the voltage marked on the product corresponds with your supply voltage.

This product is fitted with a 13A plug complying with BS1363.

If this plug is unsuitable or needs to be replaced, please note the following: Important: The wires in the mains lead are Coloured in accordance with the following code:

GREEN/YELLOW-EARTH

BLUE-NEUTRAL

BROWN-LIVE

For UK use only – Plug fitting details (where applicable):

As the colours of the wires in the mains lead of this appliance may not correspond with the coloured markings identifying the terminals in your plug, proceed as follows:

The GREEN/YELLOW wire is the EARTH and must be connected to the terminal which is marked with ⊕ the letter E or by the earth symbol or coloured GREEN or GREEN/YELLOW.

The BLUE wire is the NEUTRAL and must be connected to the terminal marked with the letter N or coloured BLACK.

The BROWN wire is the LIVE wire and must be connected to the terminal marked with the letter L or coloured RED.

Always ensure that the plug cord grip is fastened correctly.

If a 13A (BS1363) fused plug is used it must be fitted with a 13amp fuse conforming to BS1362 and be BSI or ASTA approved.

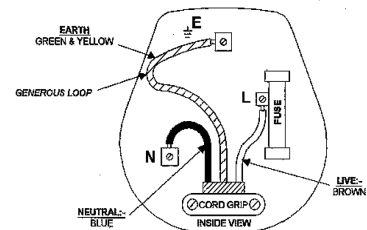

If your appliance is supplied with a non-rewireable plug fitted to the mains lead you will find that it incorporates a fuse, the value of which is indicated either on the base of the plug or on the fuse carrier. Should the fuse need replacing, you must use an ASTA approved fuse (conforming to BS1362) of the same rating. If the fuse cover is lost the plug must not be used until a replacement is obtained from an electrical supplier. If you need to remove the plug, cut it from the mains lead and dispose of it. Never attempt to re-use this plug or insert it into a socket outlet, as there is a very great risk of an electric shock.

SPECIFICATIONS:

Rated voltage:	230V~50Hz,
Operating frequency:	2450MHz
Power output:	800W
Grill	1000W
Outside Dimensions:	262mm(H) x 452mm(W) x 395mm(D)
Oven capacity dimensions	210mm(H) x 315mm(W) x 314mm(D)
Oven Capacity:	20 Litres
Weight:Approx.	12.5kg

Important:

**For expert product advice,
please phone the
Russell Hobbs
helpline on**

0844 8793277

Monday-Thursday: 9am until 5pm

Friday: 9am until 4pm

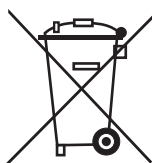

Revision 2

This symbol is known as the 'Crossed-out Wheelie Bin Symbol'. When this symbol is marked on a product, it means that the product should not be disposed of with your general household waste. Only discard electrical/electronic items in separate collection schemes, which cater for the recovery and recycling of materials contained within. Your co-operation is vital to ensure the success of these schemes and for the protection of the environment.

We reserve the right due to possible changes to design to alter the instruction manual without prior notice.